

LED Multi-SealLite[®] Matrix

- Virtually zero maintenance with 50,000 hour LED lifespan.
- Over five times more efficient than comparable halogen lamps.
- Super rugged, highly vibration and shock resistant.
- Thermal monitoring allows operation in air or water.
- 6000m depth rated.

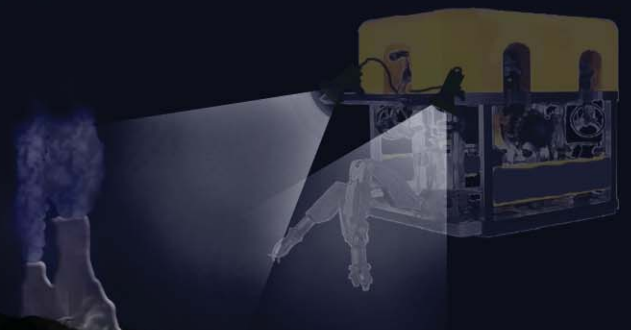

DEEPSEA
POWER & LIGHT[®]



LED Multi-SeaLite® Matrix

The revolutionary LED Multi-SeaLite® Matrix from DeepSea Power & Light will change the way you look at underwater lighting. Gone are the days of downtime caused by lamp changes. The LED Multi-SeaLite® Matrix has a 50,000 hour lifespan, and is incredibly shock and vibration resistant. The Matrix's high color temperature white LEDs and state of the art optics give you the ability to put light where you need it and reduce wasted light that is often experienced as backscatter. DeepSea's proprietary driver circuitry, and high efficiency LEDs combine to create a fixture that produces over five times more light per watt than comparable halogen lamps. To top it all off, you can easily convert your current suite of Midwater or Deep Multi-SeaLites® to the LED Multi-SeaLite® Matrix, using the same cowls, bodies, mounts, and connectors that you keep in your spares kit. The Multi-SeaLite® Matrix is the plug-n-play halogen replacement that you have been waiting for.

MECHANICAL	
Body Material	Hard Anodized Aluminum (6061)
Window Material	Acrylic
Mounts	High Strength Plastic Mounting Collar (standard) Stainless Steel Yoke Mounting Bracket (optional) Helmet Mounting Bracket (optional)
Air Weight	757g (26.7oz)
Water Weight	367g (12.9 oz)
Implodible Volume	55cc (3.4 ci)
ENVIRONMENTAL	
Depth Rating	6,000m (20,000ft)
Test Pressure	10,000 psi
Crush Depth*	9,700m (31,000ft)
Min/Max Operation Temp.	-10°C to 40°C (14° to 104°F)
OPTICAL	
Color	White
Lumens in the Water**	2600 lumens
Color Temp	6500°K
Beam Pattern***	Flood: 70°
ELECTRICAL	
Input Voltage	85 - 135v AC (100 - 180v DC) 185 - 265v AC(200 - 300vDC) 9 - 32v DC
Current Draw	550ma @ 120v AC
True Power	44w
Power Factor	0.66
Dimming	0%-100% via triak dimmer or 1v-10v contol loop
LED Lifespan	50,000 hours

*Crush depth is based on one sample only.

**True amount of light leaving the fixture, as measured with a calibrated integrating sphere. (calibration traceable to NIST)

***Beam angle measured to full width half power.



DEEPSEA
Power & Light®

4033 Ruffin Rd
San Diego, CA 92123
ph: (858) 576-1261

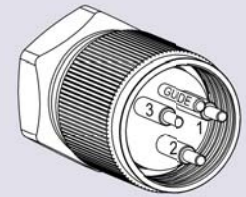

BH3MP

(1=Hot, 2=Neutral, 3=Ground to shell)

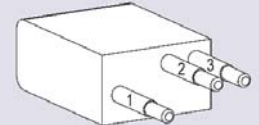

LPBH3MP

(1=Hot, 2=Neutral, 3=Ground to shell)

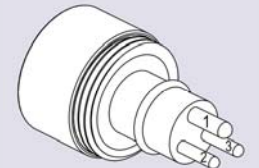

XSG3BCL

(1=Ground to shell, 2=Hot, 3=Neutral)

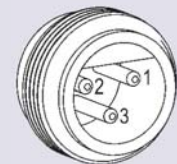

1503

(1=Hot, 2=Neutral, 3=Ground to shell)

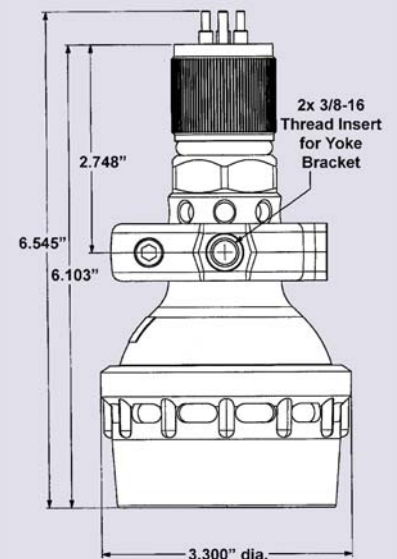
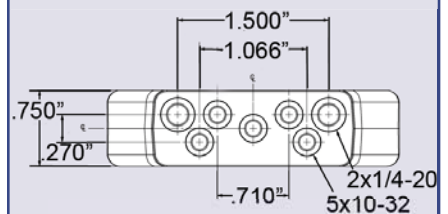

www.deepsea.com
info@deepsea.com
fax: (858)576-0219